

System description of EY-modulo 5

7010078003 C

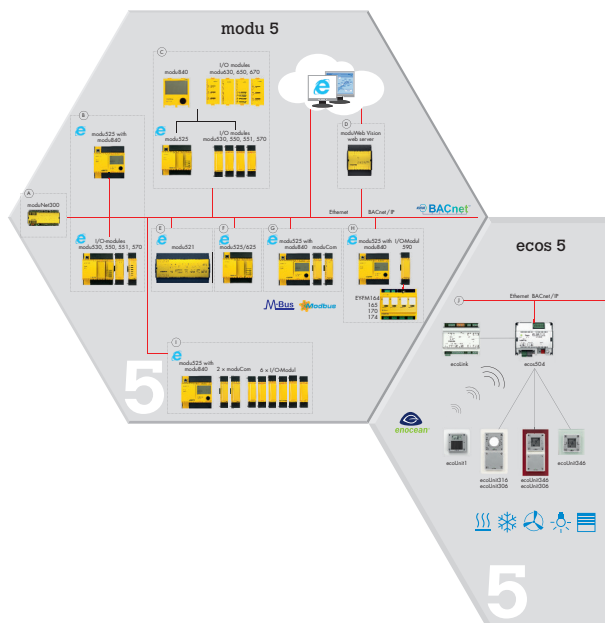

Contents

| | | |
|------------|---|-----------|
| 1 | Introduction | 5 |
| 2 | System overview | 7 |
| 3 | modu 5 automation stations | 11 |
| 3.1 | modu525 and modu524 automation station | 11 |
| 3.2 | modu5** I/O modules | 14 |
| 3.2.1 | modu590 novaLink module | 16 |
| 3.3 | modu840 local operating unit | 16 |
| 3.4 | modu625, 630, 650 and 670 local override and indication units | 17 |
| 3.5 | Remote fitting of local operating unit | 18 |
| 3.6 | Web operation / web services | 19 |
| 4 | ecos 5 room automation | 21 |
| 4.1 | ecos500, ecos502, ecos504/505 room automation station | 22 |
| 4.2 | ecoUnit room operating units | 25 |
| 4.3 | ecoUnit-Touch room operating units | 27 |
| 4.4 | Remote ecoLink I/O modules | 28 |
| 5 | BACnet communication protocol | 33 |
| 5.1 | BACnet | 33 |
| 5.2 | Native BACnet | 34 |
| 5.3 | BACnet/IP | 34 |
| 5.4 | Topologies / access / security | 35 |
| 6 | Central building management and visualisation | 37 |
| 6.1 | SAUTER Vision Center software | 37 |
| 6.2 | SAUTER Engineering Suite | 38 |
| 7 | Backwards and downwards compatibility, system integration | 39 |
| 7.1 | SAUTER EY3600 and SAUTER EY-modulo 2 via moduNet300 | 39 |
| 7.2 | System integration via EY-modulo 5 with moduCom | 41 |
| 7.3 | Third-party and SAUTER systems via SAUTER Vision Center | 42 |
| 7.3.1 | SAUTER EY-modulo 2 and EY3600 | 42 |
| 7.3.2 | LON, SAUTER EY-modulo 4 | 43 |
| 7.3.3 | OPC UA | 43 |
| 7.3.4 | API interface | 43 |
| 8 | Integrated CASE Suite service | 45 |
| 8.1 | CASE Builder | 46 |
| 8.2 | CASE Engine | 47 |
| 8.3 | CASE Vision | 48 |
| 8.4 | CASE Library Management | 48 |
| 8.5 | Components | 48 |
| 8.6 | Tools | 49 |

| | | |
|-----|--------------------------------------|----|
| 8.7 | Communication | 50 |
| 9 | Example applications | 51 |
| 9.1 | Railway station buildings in Austria | 51 |

1 Introduction

EY-modulo 5 is the **high-end building management system from SAUTER**. It is our most powerful system and can handle all functions required within the area of technical building automation. From precise climate control and regulation and various alarm functions to the convenient room reservation application, etc. The functions are integrated and limitlessly scalable within a single system.

As a “native” **BACnet system**, it is open by nature. All relevant functions, devices and applications from third parties can be integrated. It is both backwards and downwards compatible with all other SAUTER EY systems.

The communication medium used is the general network technology **Ethernet** with the **Internet protocol IP**.

The automation stations have integrated **web technology** for intuitive operation via a web browser on the Intranet/Extranet/Internet, as well as via comprehensive **local display and operating functions** on the station.

The room automation stations are used for integrated room automation, to control the room climate, the lighting and the sunshading via blinds, for example. The regulators are designed with BACnet/IP for 2, 4 or 8 rooms, either centrally with ecos500/502 or modularly with ecos504/505. The controllers can be complemented with room operating units and input/output modules. Additional digital interfaces allow direct integration of DALI, KNX, SMI and other field bus systems.

Together with the project processing and engineering software **CASE Suite** and the **SAUTER solution libraries**, where the entire SAUTER HVAC knowledge is implemented, projects can be realised very efficiently.

The **overall system**, comprising the EY-modulo 5 stations, the moduWebVision BACnet web server, the SAUTER Vision Center management level, the CASE Suite engineering software and the SAUTER solution libraries, represents an extremely comprehensive and high-performance package to **increase the energy efficiency** of buildings.

2 System overview

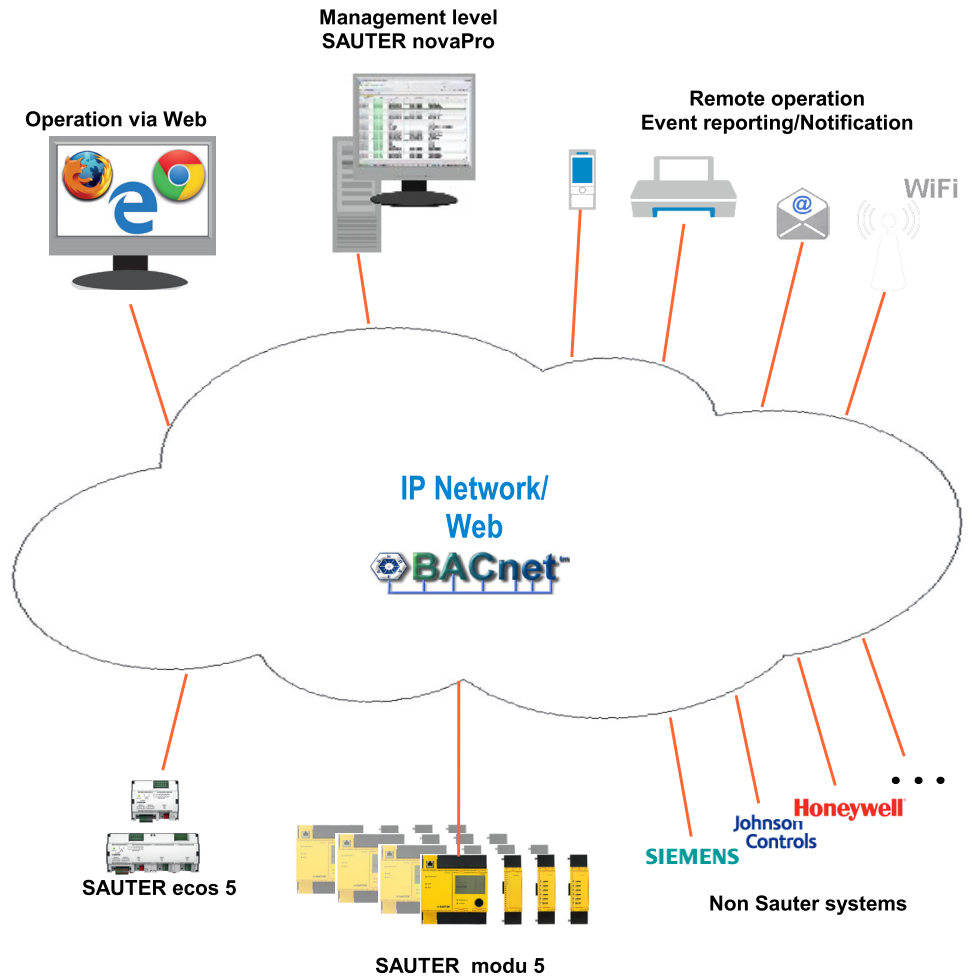

The modu 5 automation stations and the ecos 5 room automation stations form the heart of this complete system family for the regulation, control and monitoring of building service systems.

The overall system comprises the following components:

- **SAUTER modu 5** modular automation stations
- **SAUTER ecos 5** room automation stations
- management level with **SAUTER Vision Center**
- **SAUTER CASE Suite** engineering software
- the **SAUTER solution libraries**

To these are added the devices for third-party connections without BACnet functionality and, for backwards and downwards compatibility with other SAUTER EY systems, the following:

- interface module for SAUTER moduCom system integrations
- SAUTER moduNet300 BACnet application master
- novaNet OPC server for direct connection to SAUTER Vision Center

System overview

(See section 7: “Backwards and downwards compatibility, system integration”)

As a communication medium between all elements, the network technology **Ethernet with IP**, which is now commonly used, has been chosen. This means that the components can be deployed across the Intranet, Extranet and Internet.

All stations use **native BACnet technology** and communicate using the standardised, open communication protocol **BACnet/IP**. This means that the system is generally open for the integration of all BACnet components and systems from other manufacturers.

The **modu525 modular automation station** is intended for control and regulation tasks in the area of primary energy preparation. It has a modular structure. The number of inputs and outputs available in the base station (16/10) can be expanded with up to 8 I/O modules if required (up to a total of 154 I/O inputs and outputs).

The slottable **modu840 LCD operating device** can be used to view and make comprehensive use of all information in modu525. Slottable **modu 6 local operating and indicating units** allow the inputs and outputs to be directly displayed and operated. With help from the mounting frame (accessory), local operation can also be carried out at the front of a control cabinet, for example.

The modu525 automation station has **integrated web technology** with the **moduWeb web server**. This allows the station's data to be visualised and used directly with every web browser. Any networked device with a web browser, e.g. desktop PCs or laptops, panel PCs, touch-panels, Apple computers, and mobile clients such as smartphones can be used. The integrated web technology also enables the station to send alerts directly via **e-mail, SMS, fax** etc.

Room automation (IRC) is performed by means of the **ecos 5** room automation stations. These stations allow energy-optimised room control, including control of window blinds and lights. The range includes the ecos502 (designed for 2 rooms or 2 room segments) up to the ecos505 for 8 rooms or 8 room segments with digital interfaces for DALI, KNX and SMI.

The ecos 5 modular room automation system comprises the ecoLink-type input and output modules and the ecos504/505 room controllers. The room controllers allow direct integration of actuators and sensors via bus (RS-485).

Local operation of the **ecos 5** room automation stations is via the **ecoUnit-type room operating units**, which are available in various versions. They are used for temperature detection in the room and, depending on the version, for setting presence and absence individually, for the room setpoint correction and for controlling the lights and the blinds.

The browser-based (and thus independent from the operating system and the devices) SAUTER Vision Center management level is used for comprehensive operation and management. To this end, events and logs can be forwarded to

various destinations such as printers, e-mail, fax, paging devices etc. based on time and priority.

modu 5 automation stations

3 modu 5 automation stations

The modu524 and modu525 automation stations are generally used in building energy provision.

3.1 modu525 and modu524 automation station

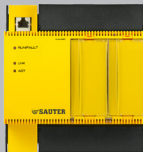
| Type |  EY-AS525F001 EY-AS525F005 |  EY-AS524F001 |
|--|---|---|
| Name Device Family Protocol Certification | modu525 modular AS with web server modu 5 BACnet/IP AMEV profile AS-B- | modu524 modular AS with web server modu 5 BACnet/IP – |
| Inputs Universal inputs Digital inputs with voltage applied Overvoltage protection | 8 (Ni/Pt1000 U/I/R; DI) 8 DI ✓ up to 24 V~ | 8 (Ni/Pt1000 U/I/R; DI) 8 DI ✓ up to 24 V~ |
| Outputs Analogue outputs with voltage applied Digital outputs various phases potential-free Watchdog output | 4 (0...10 V) (up to 5 mA) ✓ 6 relays (230 V, 2 A) ✓ ✓ 1 (open collector, pulsed) | 4 (0...10 V) (up to 5 mA) ✓ 6 relays (230 V, 2 A) ✓ ✓ 1 (open collector, pulsed) |
| Objects Data points of which hardware of which third-party systems Loop Calendar Schedule Notification Class Trend Log Total entries | up to 512 up to 154 up to 512 32 16 64 16 100 30,000 | up to 512 up to 154 up to 512 32 16 64 16 100 30,000 |
| Miscellaneous Cycle time Interfaces | 100 ms 1 Ethernet RJ-45 (10/100 Mbit/s) | 100 ms 1 Ethernet RJ-45 (10/100 Mbit/s) |
| System-int. interfaces (optional) modu721 - (RS-232+RS-485) modu731 - (RS-232+M-Bus) | Modbus/RTU, M-Bus M-Bus | Modbus/RTU, M-Bus M-Bus |
| Buffer battery period Power supply Expandability with modules | 5 years 230 V~ (F001), 24 V ~/= | 5 years 230 V~ |
| | up to 8 modules (max. 8 I/O, max. 2 COM modules) | up to 3 modules (max. 2 I/O, max. 2 COM modules) |

modu 5 automation stations

The **modu525/524** automation station (AS) is a modular unit in the EY-modulo 5 system family. It is used for control and regulation within building automation (BA) as per EN ISO 16484. It is designed as a **native BACnet device**.

The **modu525** uses powerful processor technology and all functions are based on a Linux operating system. Short cycle times allow challenging control and regulation tasks.

The basic **modu525** device contains the processor, the voltage supply, communication and other central functions. It has 16 inputs (of which 8 are universal inputs) and 10 outputs.

LEDs on the front indicate the current operating status of the device.

Optionally, the station can be complemented with the **modu840 local operating device**, or with **local operating/indicating units**. (See sections 3.3, 3.4.). The operating/indicating units can be labelled individually with a **paper insert** in the front transparent cover.

Assembly is on a DIN rail (EN 50022) in a cabinet. Connection to the Ethernet is via a standard RJ45 connector and a patch cable (Cat 5).

The programming/parameterisation is done from a PC using the SAUTER engineering software **CASE Suite** (based on IEC 61131-3). Additionally, comprehensive **CASE solutions libraries** are available for all building management applications. The user program is saved in a flash memory to protect against power failure.

An **insertable lithium button-cell battery** ensures that the RTC for time programmes (schedule/calendar) and data such as meters, adaptive control algorithms and historical data (Trend Log) are retained in the memory (SRAM).

A **watchdog signal** (open collector) is available at terminal 01 and this can be used to allow the automation station's function to be monitored, e.g. by a second AS.

The **universal inputs** (UI) can be parameterised freely as temperature, voltage or current measurements or as binary inputs. This allows optimum usage of the I/O mix of the AS or the I/O modules, reducing the number of data points that cannot be used.

In addition to the control and regulation functions, there are comprehensive **time and calendar functions** as well as parameterisable recording of **historical data**. Up to 64 BACnet time programme objects (scheduler) can be created, as can up to 16 BACnet calendar objects (calendar) and 100 BACnet Trend Log objects in the automation station. Recording of historical data can either be performed periodically (time interval) or in a threshold-based (COV) manner. Up to 30,000 entries are possible per Trend Log object in the AS. The integrated moduWeb web

server allows data points to be recorded for web operation independently of the Trend Log objects (periodical, time interval 1 min).







As a “**BACnet server**” the AS provides its objects and the associated properties externally, together with the necessary services. Typical users (“BACnet clients”) of this information include open management systems, bus-wide operating devices, other “BACnet-capable” regulators etc. As a “**BACnet client**”, the AS supports “peer-to-peer” transmission. (See also section 5: “BACnet communication protocol”)





The integrated **moduWeb web server** allows complete operation and visualisation of all objects using a standard Internet browser. Visualisation and operation are ergonomic and intuitive via websites that have been specially optimised for PCs or mobile clients, with object lists, operating screens for the calendar and time programme objects etc. Dynamic images of the system, and additional pages, can be created using CASE Suite. For the web pages, user-specific access rights can be defined. Integrated **e-mail services** allow forwarding of defined events via e-mail (using Unified Messaging Provider, SMS/fax is also possible) (see also section 3.6: “Web operation / web services”)

modu 5 automation stations

3.2 modu5** I/O modules

With the pluggable **modu530..572 I/O modules**, the number of available inputs and outputs in the basic device (16/10) can be extended, if required, to a total of 154 inputs and outputs (max. 8 I/O modules for modu525, max. 2 I/O modules for modu524).

| Type |  EYIO530F001 |  EYIO531F001 |  EYIO532F001 |  EYIO533F001 |  EYIO550F001 |  EYIO534F001 |
|--|--|--|--|--|--|--|
| Name Device | modu530 I/O module, digital/universal inputs modu524/525 | modu531 I/O module, digital inputs modu524/525 | modu532 I/O module, universal inputs modu524/525 | modu533 I/O module, universal, digital, SO inputs modu524/525 | modu550 I/O module, digital outputs (relay) modu524/525 | modu534 I/O module, analogue inputs modu524/525 |
| For stations | | | | | | |
| Digital inputs | 8 (up to 50 Hz) | 16 (up to 10 Hz) | | 8 (of which 4 SO) (up to 50 Hz) | | |
| Universal inputs Analogue Digital | 8 Ni/Pt1000 U/I/R/Pot DI (up to 3 Hz) | | 16 Ni/Pt1000 U/I/R/ Pot DI (up to 3 Hz) | 8 Ni/Pt1000 U/I/R/Pot DI (up to 3 Hz) | | |
| Digital outputs | | | | | 6 (relay 0I, 24..250 V~, 2 A, potential-free) | |
| Analogue inputs | | | | | | |
| Analogue outputs | | | | | | 8 (with power applied) |
| Optional operating elements | modu630 | modu630 | modu630 | modu630 | modu630/ modu650 | – |
| Connections to AS Power supply | insertable from modu524/25 | insertable from modu524/525 | insertable from modu524/525 | insertable from modu524/5225 | insertable from modu524/525 | insertable from modu524/525 |

| Type |  |  |  |  |
|--|---|---|---|---|
| | EY-IO551F001 | EY-IO570F001 | EY-IO571F001 | EY-IO572F001 |
| Name Device | modu551 I/O module, digital outputs (open collector) | modu570 I/O module, analogue outputs/universal inputs | modu571 I/O module, digital inputs/outputs (open collector) | modu572 I/O module, analogue outputs, universal and digital inputs |
| For stations | modu525 | modu525 | modu525 | modu525 |
| Digital inputs | | | | 3 (up to 10 Hz) |
| Universal inputs Analogue Digital | | 8 Ni/Pt1000, U/I/R/Pot DI (up to 3 Hz) | | 8 Ni/Pt1000, U/I/R/Pot DI (up to 3 Hz) |
| Digital inputs/outputs | | | 16 (open collector, up to 10 Hz/100 mA) | |
| Digital outputs | 16 (0-1), open collector, up to 100 mA) | | | |
| Analogue outputs | | 4 (0...10 V, push pull up to 2 mA) | | 4 (0..10 V/0..20 mA source, up to 20 mA) |
| Optional operating elements | modu630/ modu650 | modu630/ modu670 | modu630/ modu650 | modu630/ modu670 |
| Connections to AS Power supply | insertable from modu524/525 | insertable from modu524/525 | insertable from modu524/525 | insertable from modu524/525 |

The I/O modules are arranged directly on the right-hand side of the AS and are thus connected with the I/O bus plug. The power supply is via the AS.

The I/O module is generally comprised of two components: the **baseplate** in which the I/O bus system and the connection terminals are integrated and the **electronics**. The AS automatically detects whether a module is plugged into the I/O bus. Assignment of the I/O modules to the AS is via CASE Suite.

Optionally, the I/O modules can be complemented with **local override and indication units (LOI)**, which allow local indication and manual override of outputs on site. (See section 3.4)

All operating and indicating units can be labelled individually with a **paper insert** in the front transparent cover.

modu 5 automation stations

3.2.1 modu590 novaLink module

| | |
|---|--|
| Type |  EYLM590F001 |
| Name | modu590 |
| Device | novaLink module |
| For stations | modu524/525 |
| Number of field modules | 8(24 V=)/6(24 V~) |
| Field module type connection | moduLink1 **/novaLink1 ** |
| Local operating and indicating unit (LOI) | EYLO630F001 (optional) |
| Connections to AS Power supply | insertable from modu524/525 for module 24 V =/~ external for moduLink |

The module is used to expand the modu524/525 automation station, allowing connection of the moduLink field modules EY-FM 1** or the novaLink field modules EYY 1** to EY-modulo 5. In existing systems with EY3600 automation stations, existing decentralised input and output modules of type EYY 1** can be connected to the modu524/525 automation station.

The modu590 module is supplied with 24 V independently of the modu524/525 automation station. This guarantees autonomous operation of the field modules, even if the power supply of the automation station fails.

The connection of the novaLink module to the automation station is the same as that of the I/O modules. (See section 3.2)

3.3 modu840 local operating unit

| | |
|--------------|---|
| Type |  EY-OP840F001 |
| Name | modu840 |
| Device | Operating device |
| Function | Visualisation, operation |
| Display | Structured installations |
| For stations | modu525 |
| Interfaces | I/O bus |
| Power supply | from AS |

The **modu840** local operating panel (LOP) is latched directly into the front of the automation station in a recessed position or, alternatively, it can be fitted remotely in the cabinet door using an installation frame.

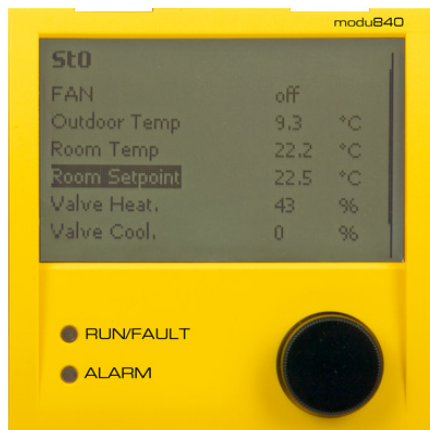





It allows direct, **comprehensive operation** of the relevant modu524/525. Turning and pressing visualises the data points in the plain text display; they can also be operated, if necessary.

The operating device does not require **any configuration**. All necessary project-specific data is stored in the automation station.

The connection is made directly on the front of the station, meaning that simultaneous operation using the operating/indicating units within the base station is not possible.

3.4 modu625, 630, 650 and 670 local override and indication units

The modu524/525 AS and its I/O modules can be complemented with **local override and indication units (LOI)**, which allow indication with LEDs and manual override of outputs on site using switches or sliders.

| Type |  |  |  |  |  |
|------------------|---|---|---|---|---|
| | EY-LO625F001 | EY-LO630F001 | EY-LO650F001 | EY-LO650F002 | EY-LO670F001 |
| Name | modu625 | modu630 | modu650 | modu650 | modu670 |
| Function | Operating/indicating unit | Indicating unit | Operating/indicating unit | Operating/indicating unit | Operating/indicating unit |
| Operation | 6xA-0-1, 4xA-0..100% | 16xLED alarm/status | 6xA-0-1 | 3xA-0-1-2 | 4xA-0..100% |
| Indication | 4+8 LED alarm/status | modu524/525 | 4xLED alarm/status | 4xLED alarm/status | 8xLED alarm/status |
| For stations Use | modu524/525 | modu524/525, 530..572 | modu524/525, 550, 551, 571 | modu524/525, 550, 551, 571 | modu524/525, 570, 572 |
| Interfaces | I/O bus from AS or I/O mod | I/O bus from AS or I/O module | I/O bus from AS or I/O module | I/O bus from AS or I/O module | I/O bus from AS or I/O mod |
| Power supply | | | | | |

modu 5 automation stations

The units can be inserted directly, in a recessed position, into the front of the automation station or the I/O modules or can be fitted remotely in the cabinet door using the **installation frame**, which is available as an accessory. The units can be installed and removed during operation without affecting the functions of the AS (hot-pluggable). The switch or slider positions are detected and implemented by the AS directly. No parameterisation is required.

The **LEDs** show the current status of the relevant input/output signals as standard (analogue signals indicate a violation of the limit value). But **free LEDs** (free channel) can also be allocated using CASE programming as an indicator for functions such as collective alarm, violation of limit value, etc. Generally, for status information the LED lights up in green and for alarms it lights up permanently in red. The **BACnet function of alarm acknowledgement** allows unacknowledged alarms to flash and, if they are acknowledged but still active, to remain lit permanently. In the case of outputs (DO and AO), a yellow LED is also activated in the manual mode (manual override) position.

The local operating and indication units are labelled with function-specific symbols or numbers. Additionally, individual labelling can be made with a **paper insert** in the front transparent cover.

3.5 Remote fitting of local operating unit

The 4-fold front frame (available as an accessory) and the appropriate connection adapters allow remote (max. 10 m) fitting of the override and indicator devices (e.g. in the cabinet door).



Required components: The 4-fold front frame (0930240511, incl. fixing bracket), the desired number of connection adapters (0930240541 for the modu840 operating device, one 0930240540 per modu625...modu670 operating and indicating unit), as well as one patch cable per unit (RJ45 \geq Cat5):



The use of the 4-fold front frame also allows simultaneous operation of modu840 and the modu625 operating/indicating unit with the modu525 basic unit.

3.6 Web operation / web services

Thanks to **moduWeb**, the **web server** integrated into the automation station, every automation station offers operation via a web browser. For the operation and maintenance of an EY-modulo 5 system, there is thus – even without a **management level** – an intuitively operable user interface that can be optimally integrated into modern IT infrastructures of a building or of the operating company.

The screenshot shows the 'moduWeb - Bhf Ried T1' interface. On the left is a navigation menu with categories like 'Status', 'Heizgruppe 1', 'Elektro', and 'Datenpunkte'. The main area displays a table of functional groups with their current values and status.

| Funktionsgruppen | Details | Istwert | Status |
|--|---------|---------|--------|
| WWB Zirkulationspumpe | | | |
| Zirk.-Pumpe - H04 Zirk.-Pumpe SB | [Icons] | 0 | ✓ |
| Zirk.-Pumpe - H04 Zirk.-Pumpe Stoer. | [Icons] | 0 | ✓ |
| WWB Speicher: Fühler mitte | | | |
| Temp. Speicher - H04 Temp. Speicher | [Icons] | 100 | ✓ |
| WWB Solar indirekt: WT, Pumpe, Kollektortemp. | | | |
| Solarpumpe pri. - H04 Solarpumpe pri. SB | [Icons] | 0 | ✓ |
| Solarpumpe pri. - H04 Solarpumpe pri. Stoer. | [Icons] | 0 | ✓ |
| WWB indirekt primär: VL-Fühler | | | |
| VL-Temp. pri. - H04 VL-Temp. pri. | [Icons] | 100 | ✓ |

Operating the AS via **moduWeb** is by means of a **standard web browser**, i.e. from any PC, Mac, Notebook or smartphone, etc. The operating devices do not need any configuration. For mobile clients with a small screen, there is a specifically adapted version.

The **data point lists** etc. are generated automatically based on the project-specific data that is stored on the automation station. In addition, **dynamic system images** can be generated with CASE Suite and stored on the web server.

modu 5 automation stations

With the right configuration, moduWeb can also forward alarms and historical data to any **e-mail address**. Using Unified Messaging Providers, these e-mails can also be forwarded to **fax** or **SMS** destinations.

Scope of functions of moduWeb:

- Representation of data points:
 - data point list (linear/structured)
 - dyn. system images (can be generated with CASE Suite)
- Data recording in moduWeb:
 - representation as a graph or table
- Export of recorded data as a file or via e-mail.
- Control loops:
 - colour-coded control loop representation
 - direct parameterisation option for control parameters (Xp, Tn, Set...)
- Operation of time programmes (schedule/calendar)
- Notification:
 - use of BACnet Intrinsic Reporting
 - representation of current alarms in a sortable list
 - alarm messages that can be acknowledged
 - representation of historical alarms
 - notification via e-mail
- Adjusted representation for mobile clients
- Online language change:
 - German, English, French, 1 additional language
- User management:
 - role concept (admin, specialist, user, guest)
 - individual release of systems and nodes



4 ecos 5 room automation

The **ecos 5 room automation stations** are a range of stations in the EY-modulo 5 family especially designed for the requirements of comprehensive room automation.

They use the same technology as the SAUTER modu 5 automation stations and are thus also **native BACnet stations** with communication via **Ethernet with BACnet/IP**. They can be completely homogeneously integrated into the EY-modulo 5 overall system.

ecos 5 room automation

4.1 ecos500, ecos502, ecos504/505 room automation station

| Type |  EY-RC.500F001/F002 |  EY-RC502F001 |  EY-RC504F0** |  EY-RC505F0** |
|------------------------------|---|---|--|---|
| Product name | ecos500 | ecos502 | ecos504 | ecos505 |
| Function | 4 room segments | 2 room segments | 8 room segments | 8 room segments |
| Power supply | 230 V~ | 230 V~ | 24 V=/~ | 24 V=/~ |
| SLC/RS-485 interfaces | 2 | 1 | 2 | 2 |
| Room operating units | 1 x 4 | 1 x 4 | 2 x 4 | 2 x 4 |
| I/O extension modules | 1 x 16 | – | 2 x 8 | 2 x 8 |
| Communication interfaces | – | – | 1 | 3 |
| Communication protocols | SLC | RU/SLC | SLC, KNX, DALI, SMI | SLC, KNX, DALI, SMI |
| Terminal type | Screw terminals (F001) Push-in terminals (F002) | Screw terminals | Push-in terminals | Push-in terminals |
| Inputs/outputs | | | | |
| Universal inputs | 8 | 8 | – | – |
| Digital inputs | 4 | 4 | – | – |
| Normally-open relay contacts | 16 | 16 | – | – |
| Changeover relay contacts | – | 2 | – | – |
| Triac | 8 | 8 | – | – |
| Analogue inputs | 4 | 4 | – | – |
| Analogue outputs | 4 | 4 | – | – |
| BACnet profile | B-BC | B-BC | B-BC | B-BC |
| Objects | | | | |
| Data points | 256 | 256 | 600 | 600 |
| Loop | 32 | 32 | 32 | 32 |
| Calendar | 8 | 8 | 16 | 16 |
| Schedule | 32 | 32 | 32 | 32 |
| Trend Log | 16 | 16 | 256 | 256 |
| Notification Class | 16 | 16 | 16 | 16 |

| Type | KNX | DALI | SMI |
|--------------|-----|------|-----|
| EY-RC504F001 | – | – | – |
| EY-RC504F011 | • | – | – |
| EY-RC404F021 | – | • | – |
| EY-RC504F041 | – | – | • |
| EY-RC505F031 | • | • | – |
| EY-RC505F051 | – | – | • |
| EY-RC505F061 | • | – | • |
| EY-RC505F071 | • | • | • |
| EY-RC505F081 | – | • | – |
| EY-RC505F0A1 | • | • | – |

The types EY-RC505F081 and EY-RC505F0A1 have 2 DALI interfaces.

The **ecos 5 room automation stations** are designed for temperature regulation and for controlling lights, blinds etc. in individually regulated rooms.

The ecos500 and ecos502 provide all inputs and outputs for room automation compactly and directly on the device.

The **ecos502** is designed for the control of **2 rooms or 2 segments** (i.e. the I/O mix of the ecos502 is adapted for 2 rooms or 2 segments); the **ecos500** is designed for **4 rooms or 4 segments**.

On the ecos500 and ecos502 stations, 8 of the 12 inputs are **universal inputs (UI)** that can be parameterised freely as temperature, voltage or current measurement inputs or binary inputs. This offers the option of **optimum use of the I/O mix** of the station.

On the **ecos500**, the I/O mix can also be expanded for more complex applications using decentrally mountable **ecoLink input/output modules**. The ecoLink modules are connected to the ecos 5 in bus form (RS-485 interface) and can be located up to 500 m away from the station (See section 4.2: Remote ecoLink I/O modules)

The **ecos504** and **ecos505** are modular stations and do not have inputs or outputs. The inputs/outputs are realised in a modular manner with the remote ecoLink I/O modules and with the integrated communication interfaces for DALI, KNX, SMI etc. The ecos504 and ecos505 are designed for controlling up to 8 rooms or room segments.

In addition to the control and regulation functions, there are also comprehensive **time and calendar functions**. Up to 32 BACnet time programme objects (schedule) and 8 BACnet calendar objects (calendar) can be created in the automation station.

ecos 5 room automation

4 or 2 x 4 connectable **room operating units** of types ecoUnit 3 (EYRU3F^{***}) or ecoUnit 1 (EY-RU1F^{***}) are used for room-temperature measurement and allow individual adjustment of the room climate to the users' requirements. (See section 4.2: "ecoUnit room operating units")

Powerful function modules in the ecos 5 stations allow **energy-optimised room control**. The following also aid the optimisation of the **energy consumption** of the controlled rooms: presence function, window contact monitoring, demand-controlled switching of fan speeds, control of lighting and window blinds, and time-dependent setpoint specification.

The complete **user program** and the different parameterisations (BACnet objects, etc.) are created using **CASE Suite**. Up to 256 or 600 BACnet data points incl. hardware inputs and outputs can be used. For programming/parameterisation in CASE Suite, comprehensive **regulating libraries** are available.

The user program and the changed data (e.g. changed by the BACnet client) are stored persistently in the **flash memory**. An insertable **lithium button-cell battery** ensures that the RTC for time programmes (scheduler/calendar) and data such as meters, e.g. adaptive control algorithms, are retained in the memory (SRAM), even if there is a power failure.

ecos 5 are compact units intended for wall mounting or for DIN 43880 series installation on a 35 mm DIN rail.

For BACnet communication, two RJ-45 network connections with integrated **Ethernet switch** functionality are available. This allows the ecos 5 to be connected in series (daisy chain wiring).

As an accessory for the ecos500 and ecos502 stations, there is a snap-on 2-part **wiring box** that allows space for the necessary connections of the neutral and earth wires and thus allows cost-effective installation of the ecos 5 without additional wiring boxes.

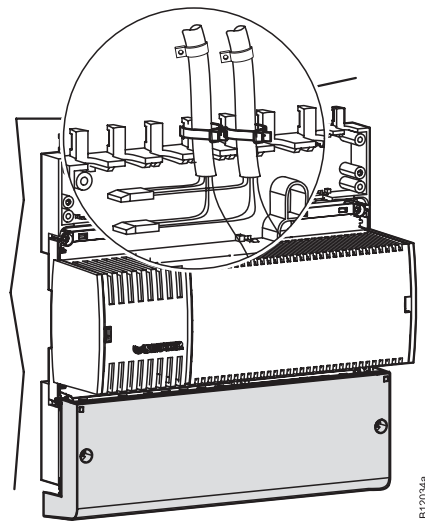

An ecos504/505 with the I/O modules is usually designed in a room box as a series installation.

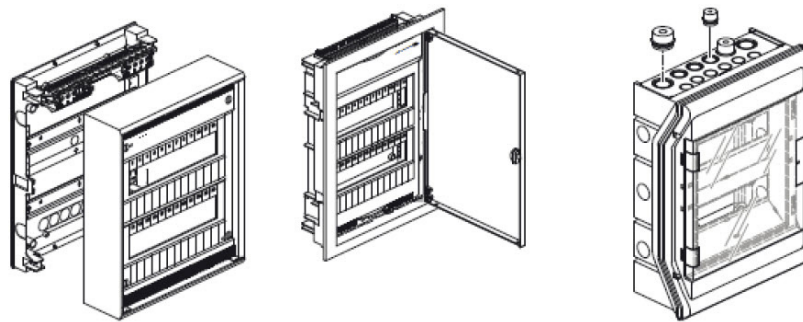





4.2 ecoUnit room operating units

ecoUnits are the room operating units for the ecos 5 room automation stations. They are used to measure the room's temperature and, depending on the type, have different operating options and a display with information about the room condition.



The range of room operating units comprises **three basic variants**:

ecos 5 room automation





 - devices with **LED indicator** (ecoUnit310..316):

| Type |  |  |  |  |
|---------------------|---|---|--|---|
| Name Usage | ecoUnit310 Temperature | ecoUnit311 Temperature | ecoUnit314 Temperature, fan, presence | ecoUnit316 Temperature, fan Presence, blinds or light |
| Indicators/display | LED | LED | LED | LED |
| Button functions | – | Rotary knob | Rotary knob | Rotary knob |
| Fan speeds | – | – | Auto-0-1-2-3 | Auto-0-1-2-3 |
| Setpoint correction | – | Variable | Variable | Variable |
| Room occupancy | – | – | 3 modes | 3 modes |
| Fan | – | – | 5 modes | 5 modes |
| NTC sensor | ✓ | ✓ | ✓ | ✓ |
| Power supply | From ecos 5 | From ecos 5 | From ecos 5 | From ecos 5 |

 - devices with **digital display** (ecoUnit341..346):

| Type |  |  |  |
|---------------------|---|---|--|
| Name Usage | ecoUnit341 Temperature | ecoUnit344 Temperature, fan, presence | ecoUnit346 Temperature, fan Presence; blinds/light (2 allocations) |
| Indicators/display | LCD | LCD | LCD |
| Button functions | – | – | 2 buttons |
| Fan speeds | – | Auto-0-1-2-3 | Auto-0-1-2-3 |
| Setpoint correction | Variable | Variable | Variable |
| Room occupancy | – | 3 modes | 3 modes |
| Fan | – | 5 modes | 5 modes |
| NTC sensor | ✓ | ✓ | ✓ |
| Power supply | From ecos 5 | From ecos 5 | From ecos 5 |

- devices with **wireless communication (EnOcean standard)** (ecoUnit110..146):

| | | | | |
|---------------------|--|--|---|--|
| Type |  EYRU110F100 |  EYRU141F100 |  EYRU144F100 |  EYRU146F100 |
| Name Usage | ecoUnit110 Temperature | ecoUnit141 Temperature | ecoUnit144 Temperature, fan, presence | ecoUnit146 Temperature, fan Presence/light |
| Indicators/display | - | LCD | LCD | LCD |
| Data transmission | Wireless (868 MHz) | Wireless (868 MHz) | Wireless (868 MHz) | Wireless (868 MHz) |
| Button functions | - | - | - | 2 buttons |
| Fan speeds | - | - | Auto-0-1-2-3 | Auto-0-1-2-3 |
| Setpoint correction | - | Variable | Variable | Variable |
| Room occupancy | - | - | 3 modes | 3 modes |
| Fan | - | - | 5 modes | 5 modes |
| NTC sensor | ✓ | ✓ | ✓ | ✓ |
| Power supply | Solar cell | Solar cell | Solar cell | Solar cell |

Within these 3 variants, the devices are ordered according to **functionality**:

- temperature detection
- additional setpoint correction
- additional fan control, presence button
- additional light and/or window blind control

All ecoUnit room operating units have a uniform installation dimension. **Installation** takes place in standardised fastening frames with a 55x55 mm section. These frames are available in many design variants, materials and colours for surface or recessed fitting from both SAUTER and third-party suppliers.

A **labelling film** behind the transparent front cover allows the room operating units to be adapted to local requirements.

Connection to the ecos 5 is via a serial connection (RS-485). On the **wireless** devices (ecoUnit110..146), communication is according to the **EnOcean standard**. Within the ecos 5, an EnOcean wireless gateway (ecoMod580) is used.

The ecoUnit room operating units are expandable with an additional **ecoUnit306** or **ecoUnit106 push-button unit**.

4.3 ecoUnit-Touch room operating units

The ecoUnit365 (EY-RU 365) touch room operating unit records the room temperature. It is used for the local operation of up to 12 setpoints for temperature control, fan control, lighting and sunshade for one or more rooms. The “virtual” buttons in the touch display are defined as function tiles. The functions defined on six pages, with up to six tiles per page, can be operated intuitively using the gesture control familiar from smartphone usage. The touch room operating unit with a Bluetooth interface (EY-RU365F0*2) enables the user to control the functions of

the ecoUnit365 using a smartphone and the “SAUTER room management” app (iOS, Android) via Bluetooth 4.0 LE.



| | |
|---------------------|--|
| Type | EY-RU365F00* |
| Name Usage | ecoUnit365 Temperature |
| Function | Temperature sensor, 12 setpoints with 4 functions (temperature, lights, blinds and fans) |
| Interface | SLC/RS-485 |
| Indicators/display | 3.5" TFT colour display |
| Temperature sensor | Yes |
| Button functions | 12 on 6 x 6 tiles |
| Fan speeds | Yes |
| Setpoint correction | Digitally adjustable |
| Room occupancy | Yes |



4.4 Remote ecoLink I/O modules

The decentrally mountable **ecoLink input/output modules** are used to expand the **I/O mix** of the ecos 5, and to reduce the **wiring costs**. The modules are connected to the ecos 5 in bus form (RS-485 interface) and can be located up to 500 m away from the station.

11 different types are available for selection:

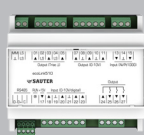
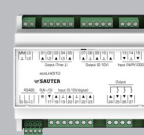
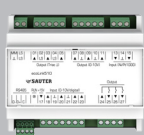
- 5 models with 24 V= \sim power supply:
 (For applications such as fan coil units, chilled and heated ceilings and activation of valve actuators etc.):





| | | | |
|------------------------------|---|--|---|
| |  |  |  |
| | EY-EM510F001 | EY-EM511F001 | EY-EM512F001 |
| Product name | ecoLink510 | ecoLink511 | ecoLink512 |
| Power supply | 24 V \sim | 24 V \sim | 24 V \sim |
| Inputs/outputs | | | |
| Universal inputs | – | – | – |
| 0-10 V / digital inputs | 4 | 4 | 4 |
| Ni1000/Pt1000 inputs | 2 | 2 | – |
| DIM-10 V outputs | – | – | – |
| Normally-open relay contacts | 3 | – | – |
| Changeover relay contacts | – | – | – |
| Triac | 3 | 3 | 2 |
| Analogue outputs | 3 | 3 | 3 |

| | | |
|------------------------------|---|--|
| |  |  |
| | EY-EM514F001 | EY-EM515F001 |
| Product name | ecoLink514 | ecoLink515 |
| Power supply | 24 V= \sim | 24 V= \sim |
| Inputs/outputs | | |
| Universal inputs | 4 | 4 |
| 0-10 V/digital inputs | – | – |
| Ni1000/Pt1000 inputs | – | – |
| DIM-10 V outputs | – | – |
| Normally-open relay contacts | 4 | – |
| Changeover relay contacts | – | – |
| Triac 24 V= | – | – |
| MOS-FET 24 V= \sim | 6 | 6 |
| Analogue outputs | 4 | 4 |

ecos 5 room automation

Supply is via an external power supply unit.

- 6 models with 230 V power supply:
(Mostly used to control lights and blinds):

| |  EY-EM520F001 |  EY-EM521F001 |  EY-EM522F001 |  EY-EM523F001 |
|------------------------------|---|---|--|---|
| Product name | ecolink520 | ecolink521 | ecolink522 | ecolink523 |
| Power supply | 230 V~ | 230 V~ | 230 V~ | 230 V~ |
| Inputs/outputs | | | | |
| Universal inputs | – | – | 4 | 4 |
| 0-10 V/digital inputs | 4 | 4 | – | – |
| Ni1000/Pt1000 inputs | – | – | – | – |
| Digital/meter inputs | – | – | – | – |
| DIM-10 V outputs | 2 | 2 | 4 | 4 |
| Normally-open relay contacts | 4 | 2 | 4 | – |
| Changeover relay contacts | – | – | – | – |
| Triac 24 V= | – | – | – | – |
| Analogue outputs | – | – | 4 | 4 |

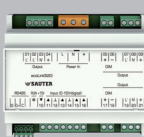
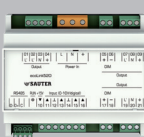
| |  EY-EM526F001 |  EY-EM527F001 |
|------------------------------|---|---|
| Product name | ecoLink526 | ecoLink527 |
| Power supply | 230 V~ | 230 V~ |
| Inputs/outputs | | |
| Universal inputs | – | 4 |
| 0-10 V/digital inputs | 4 | – |
| Ni1000/Pt1000 inputs | – | – |
| Digital/meter inputs | – | 4 |
| DIM-10 V outputs | 2 | – |
| Normally-open relay contacts | 4 | 4 |
| Changeover relay contacts | – | – |
| Triac 24 V= | – | – |
| Analogue outputs | – | – |

Up to 16 modules (ecos500) or 2 x 8 modules (ecos504/505) can be connected to the sub-bus. The I/O mix can thus be optimally adjusted to the requirements.

Every module can be assigned to a segment, which allows for the realisation of flexible rooms. The inputs and outputs of a module can, however, also be parameterised and assigned individually with CASE (segment plant). This makes it possible to use the modules optimally for flexible room segments.

BACnet communication protocol

5 BACnet communication protocol

5.1 BACnet

The **BACnet used by the EY-modulo 5** automation and room automation stations is an **open data communication protocol** for building automation (**B**uilding **A**utomation and **C**ontrol **n**etwork). This **company-neutral communication standard** defines and describes a “shared language” that supports data communication between **different systems** (heating, ventilation, fire alarm and security) and, particularly, between **devices from different manufacturers**. The aim is to **keep installations open** in the event of expansions, replacements etc.

The **BACnet standard** is a development from **ASHRAE** (**A**merican **S**ociety of **H**eating, **R**efrigerating and **A**ir-**C**onditioning **E**ngineers). It started in 1987. In 1995, BACnet became an ASHRAE/ANSI standard and, in **2003, an international standard** (ISO 16484-5) **and a European standard** (EN ISO 16484-5). The **BACnet standard** is developed continuously in different working groups.

For the mapping of the various **elements of building automation**, the BACnet standard defines relevant **BACnet objects** (e.g. analogue value, regulator etc.) and defines a number of **properties** for each object (e.g. the current value, name and number of the object, the physical unit etc.).

The standard also defines **BACnet services** for access to objects or for the execution of functions. There are a total of 38 services (e.g. reading and writing of object properties or the execution of functions in other devices such as restart, logon for alarms etc.). In addition to reading properties (e.g. the current value), there is also, and in particular, a **service for subscribing** to a value. The value (the property) is then automatically reported by the original object to the subscriber as soon as it changes (**COV notification**).

Example of analogue input:

| | |
|---------------|-------------------|
| Object_Name | SPACE TEMPERATURE |
| Object_Type | ANALOG INPUT |
| Present_Value | 22.3 |
| Status_Flags | OUT-OF-SERVICE |
| High_Limit | 24 |
| Low_Limit | 20 |

In addition to the standard objects, properties and services, the standard allows optional definition and use of **proprietary objects, features and services**.

5.2 Native BACnet

Native BACnet devices are devices that are structured **homogeneously in accordance with the BACnet standard** and that therefore require no conversion (gateway, conversation processor etc.) for **BACnet** communication. The inputs and outputs are mapped directly in the device as **BACnet objects**.

All **EY-modulo 5** stations use native BACnet technology. Not only the inputs and outputs are mapped as BACnet objects, but also most of the other objects such as control loops, calendar objects, trend objects, etc.

5.3 BACnet/IP

The **BACnet standard** supports different **communication platforms**, e.g. **PTP** (point to point) - EIA-232, **MS/TP** (master slave/token passing) - EIA-485, **Ethernet** - ISO 8802-3 (Ethernet direct, without IP), **LONtalk** and, of course, **BACnet/IP** as used by EY-modulo 5.

BACnet/IP uses the widespread **IP protocol** for communication between the **BACnet devices** (automation devices, PCs, etc.). Each individual BACnet device is IP-ready and has its own **IP address** (i.e. it is an IP node).

This allows the building automation system to be integrated into **Enterprise IP networks** or the **Internet**, and the devices can communicate with one another across the network. (See section 5.4.: "Topologies / access / security")

A **BACnet/IP network** is a virtual network that stretches across one or more IP subnetworks (IP domains) and has a single **BACnet network number**. This virtual **BACnet/IP network** contains BACnet/IP nodes that communicate with one another by means of the BACnet/IP protocol across **different physical networks** (subnets). A BACnet broadcast management device (BBMD) manages the **IP broadcasts** used by BACnet and forwards them in a targeted manner to the IP networks in question. This allows communication via several physical IP networks without placing unnecessary strain on the overall network.

5.4 Topologies / access / security

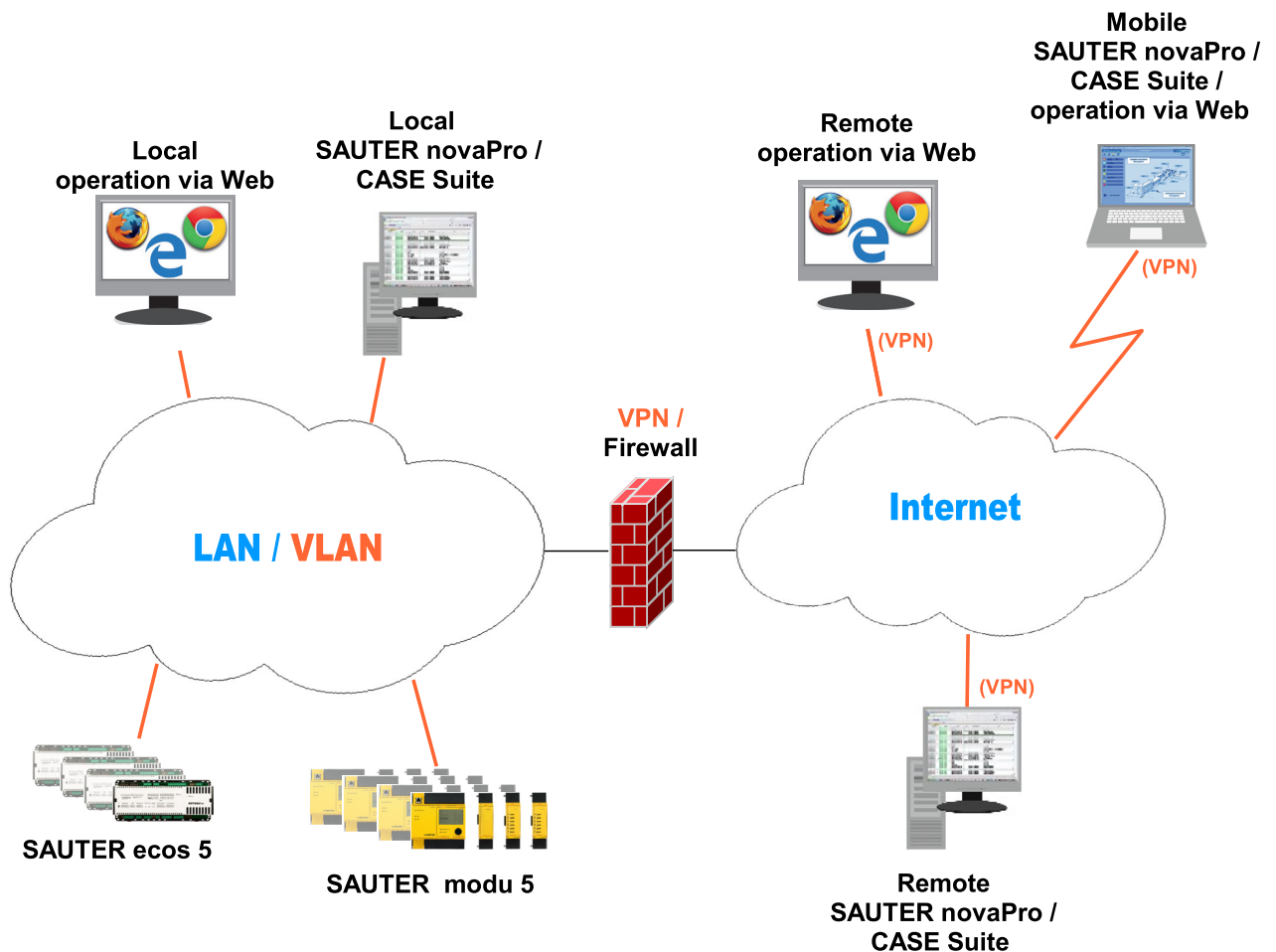

BACnet/IP can, in principle, be operated in every **IP network**. (Even the **moduWeb** functions of the AS (operation with browser, e-mail) generally fit easily into every IP LAN / WAN / Internet environment.)

Depending on the requirements, the SAUTER EY-modulo 5 BACnet/IP AS and the SAUTER GMS operating stations can be integrated directly into the existing IP network of a building (e.g. office LAN), or a physically separate **dedicated IP network** can be set up for the **building management system**.

During integration into an existing customer IP network, it is generally recommended that the BMS components be **logically separated** from the office LAN by bundling the EY-modulo 5 AS and the BMS operating stations into a **VLAN** (virtual LAN).

Except for very small systems, the bypassing of NAT router(s) and/or firewall(s) requires either a BACnet router, or a **VPN** needs to be set up for access. Access via **VPN** is also a very advisable solution. On the one hand, this is due to the clear delineation and thus **increased security** and, on the other hand, due to the simpler configuration. (Access via **VPN** means that the operating stations on the Internet

BACnet communication protocol

are integrated virtually in the LAN/VLAN of the stations using appropriate VPN client drivers.)

In any event, in order to allow access from outside, appropriate measures/**configurations** must be performed for the **Internet access / firewall**.

For this reason, **discussion and collaboration with the customer's IT managers** – even during the planning phase – **is indispensable** for the implementation in the customer's IT environment.

6 Central building management and visualisation

SAUTER Vision Center is a web-based building management solution in the HTML5 standard. It allows platform-independent operation on smartphones, tablets or desktop PCs without setting up inconvenient plug-ins. This means that personnel always have access to the new, individually configurable dashboards as a central information interface for system operation, energy consumption, associated alarms and key figures and lots more. Other detailed information such as alarm reports, interactive object lists, diagrams and reports can also be accessed directly.

6.1 SAUTER Vision Center software

SAUTER Vision Center is the perfect solution for controlling and visualising building operation. SAUTER Vision Center is suitable for both larger single buildings and entire real estate parks or distributed premises. Typical areas of use are building complexes, business parks, college and industrial campuses, airports, railway stations, hospitals or internationally distributed branch networks. The modular concept allows the software to be extended precisely to meet the customer requirements of every installation. Therefore, SAUTER Vision Center gathers all of the data for the entire building and energy management and makes it available to the user from anywhere at all times.

SAUTER Vision Center sends alarms directly via e-mail or SMS to mobile phones according to the responsibilities assigned. With its many user-defined settings and dashboards that can be customised with drag & drop, SAUTER Vision Center guarantees maximum user convenience. This enables complete concentration on the monitoring and evaluation of the installations, as well as their optimum operation, and contributes to efficient, sustainable building and energy management.

SAUTER Vision Center is BACnet-certified and thus optimally adapted to the EY-modulo 5 devices. An additional advantage of the native BACnet driver is the integration and communication with devices and systems from every manufacturer thanks to the BACnet standard.

The OPC UA client ensures a connection to various OPC servers and thus allows full connectivity with very different protocols within building automation (including KNX, M-Bus, Modbus, DALI). The direct integration of the SAUTER moduWeb Vision visualisation solution – often used as local operation – allows easy integration of small systems into SAUTER Vision Center's central visualisation.

Naturally, SAUTER Vision Center also supports the SAUTER novaNet communication protocol, meaning that even older systems can benefit from the innovations of modern building management software and can be replaced, according to requirements and available budget.

Central building management and visualisation

6.2 SAUTER Engineering Suite

The SAUTER CASE Suite Engineering Software with various modules for SAUTER devices and software packages is optimally adapted for use with SVC. In particular, CASE Vision can be used to engineer the complete SAUTER Vision Center projects and the visualisation libraries can be used to set them up efficiently and uniformly. In addition, Vision Center Studio offers a local engineering tool for direct installation on the SVC server in order to make small, quick changes or extensions “online”.

7 Backwards and downwards compatibility, system integration

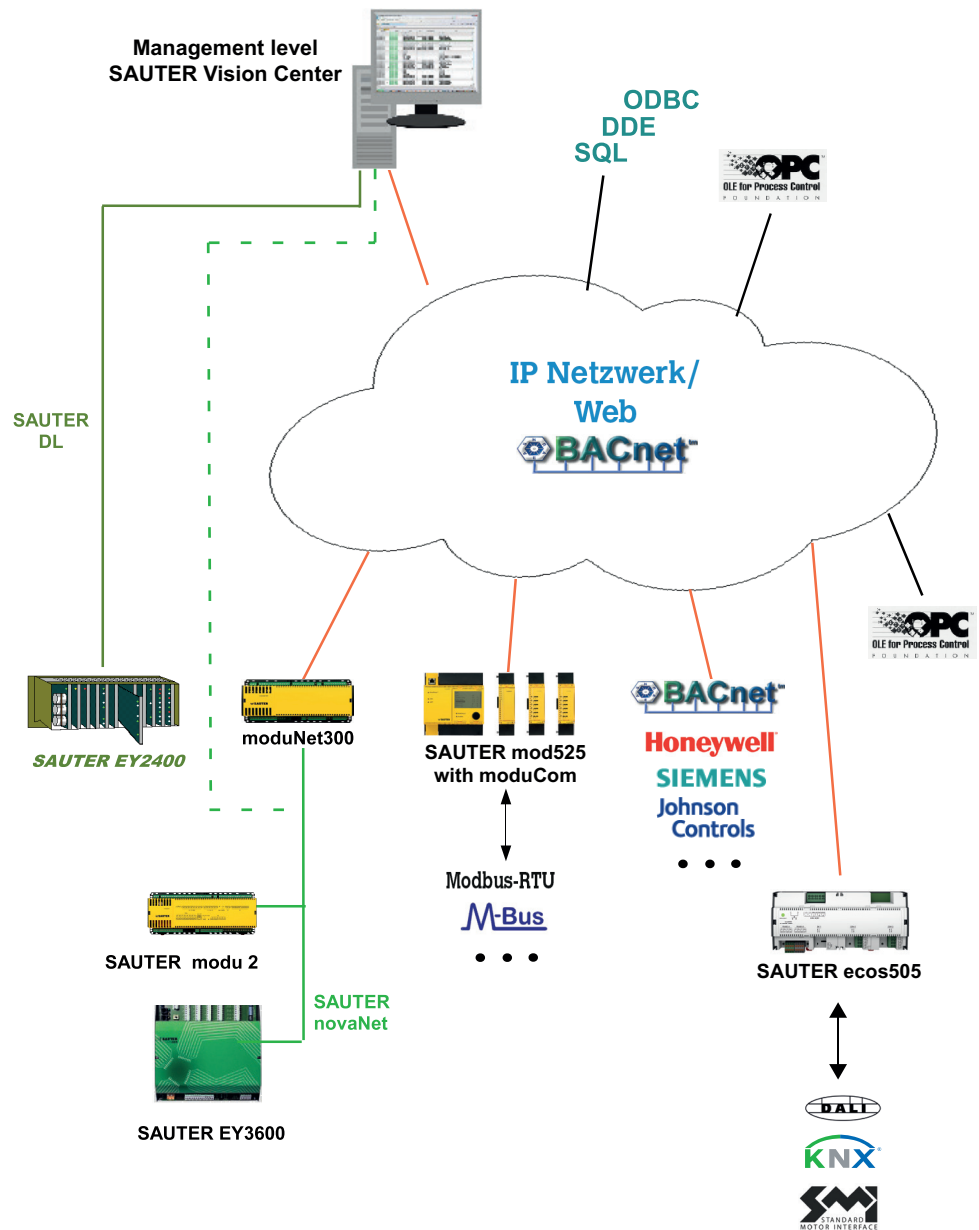

As a **BACnet system**, **SAUTER EY-modulo 5** is, in principle, open for direct integration with all third-party BACnet systems or third-party systems that have the option of connection to BACnet (e.g. gateways).

Furthermore, **SAUTER EY-modulo 5** offers various integration options for incompatible BACnet third-party systems and for the other SAUTER EY systems:

7.1 SAUTER EY3600 and SAUTER EY-modulo 2 via moduNet300

Downwards/backwards compatibility with the SAUTER EY3600 and EY-modulo 2 novaNet systems is attained by the **moduNet300 novaNet BACnet application master** (or directly from the SAUTER Vision Center management level). (See section 7.3: “Third-party and SAUTER systems via SAUTER Vision Center”). This

Backwards and downwards compatibility, system integration

means that EY-modulo 2 systems (or EY3600 systems) can be expanded with EY-modulo 5 (or other BACnet systems), or vice versa.

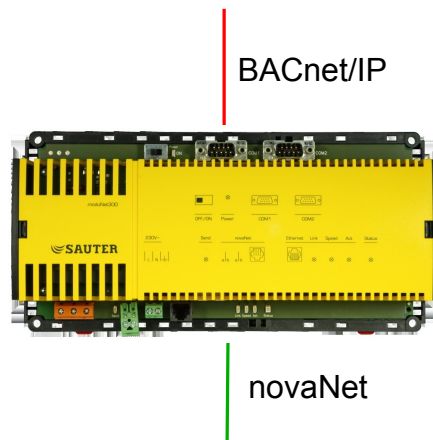

The **moduNet300 application master (AM)** integrates the SAUTER EY-modulo 2 automation stations and room controllers connected via novaNet (as well as EY3600 stations) into the open, standardised BACnet/IP communication protocol.

As a “**BACnet server**”, it provides the addresses of the novaNet AS as BACnet objects with the associated properties and the required services. As a “**BACnet client**”, the AM supports “peer-to-peer transmission” with “Present Value properties”.

For the alarms and event notifications, **notification class** objects and **event enrolment** objects are supported.

Using the scheduler that is also implemented (daily and weekly calendar) and the related BACnet objects “**Schedule**” and “**Calendar**”, it is possible to process local BACnet time programmes and thus also control process variables for the connected novaNet stations time-dependently.

Historical data can also be held on the AM with dynamically created BACnet “Trend Log” objects. This data is then persistently stored in the AM.

The BACnet objects can either be read by the BACnet clients by means of cyclical polling or actively transferred through the COV (Change Of Value) subscription mechanism of the AM.

The **addresses** used in the EY-modulo 2 (or EY3600) automation stations are implemented and updated automatically by the AM in “**BACnet objects**” for an engineered house address. No other generation work is required.

The **processing capacity** regarding “BACnet objects” is a total of 1000 objects per moduNet300 application master. Every moduNet300 used in novaNet requires a novaNet PC address.

Configuration of the IP address and other parameters is carried out with the “BACnet Server Configurator”, a software tool in the SAUTER CASE Suite.

7.2 System integration via EY-modulo 5 with moduCom

At **AS level**, the integration of systems from other manufacturers is realised via the modu525 automation station in combination with the **moduCom** communication module:

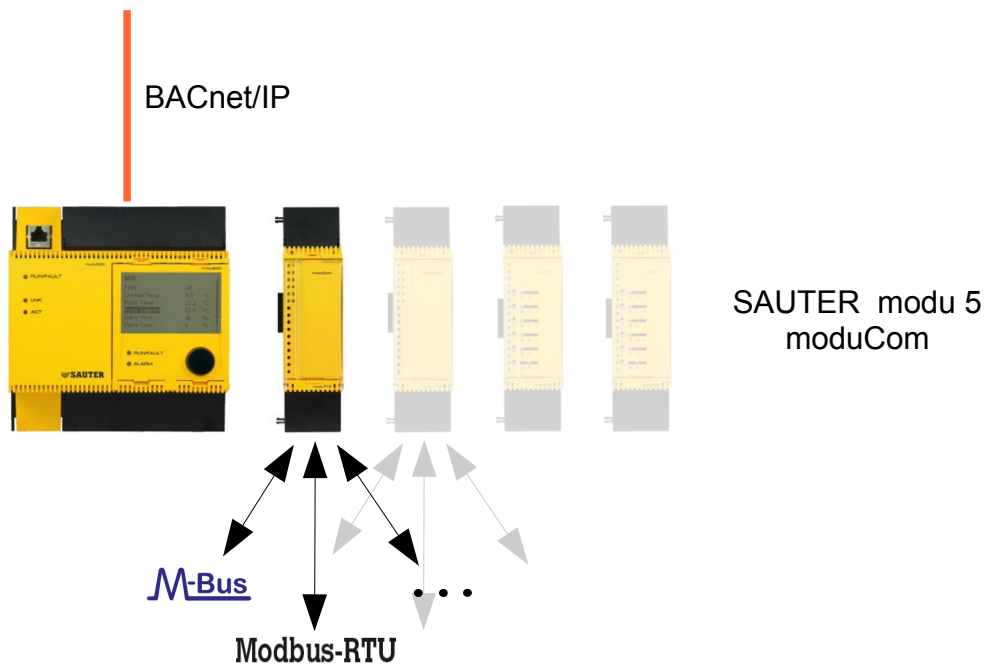

For each modu525 AS, up to **2 moduCom modules** can be inserted. These must be added at position 1 or 2. Furthermore, the modu525 can, as usual, be complemented with other I/O modules for a direct connection of equipment (max. 6 or 7 items, max. 148 I/O, a max. total of 512 BACnet objects).

The logical **AS functions** of regulation, control, optimisation, monitoring, web services etc. are available in equal measure to the directly connected equipment as for the integrated third-party system addresses.

The moduCom communication module exists in four type variants, **modu710**, **modu720**, **modu721**, **modu731** with different interfaces. All types are freely programmable with regard to data transfer protocol and can thus be adjusted for all kinds of products such as PLCs, chillers, energy meters etc.

The **modu710 with EIA-RS-232** offers the Modbus/RTU and M-Bus protocols.

The **modu720 with EIA-RS-485 bus system** offers the Modbus/RTU protocol.

The **modu721 with EIA-RS-232 and EIA-RS-485** currently offers the Modbus/RTU, M-Bus protocols.

Backwards and downwards compatibility, system integration

The **modu731 with M-Bus 2-wire interface and EIA-RS-232** offers the M-Bus protocol.

Additional protocols can be implemented on all modules upon consultation. Please contact us for the current ex-works protocols and the realisation of others.

7.3 Third-party and SAUTER systems via SAUTER Vision Center

The SAUTER management level software **SAUTER Vision Center** offers very varied **connection options**. These support connection of all additional SAUTER EY systems and a very large number of third-party systems and various databases.

Furthermore, a solution can be found based on the existing API interfaces for additional connections that are not available as standard.

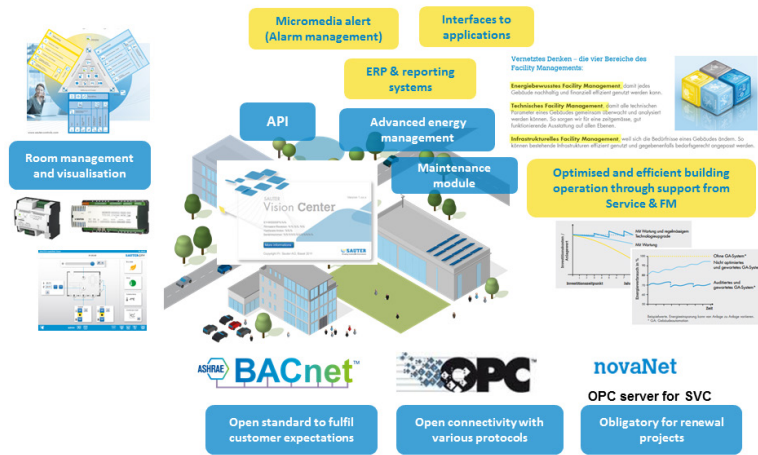

7.3.1 SAUTER EY-modulo 2 and EY3600

In addition to connection via moduNet300 (see section 7.1), **SAUTER EY-modulo 2 and EY3600 stations** (SAUTER novaNet stations) can be integrated in BACnet / EY-modulo 5 systems using the SAUTER novaNet OPC server. Existing EY-modulo 2 and EY3600 systems can also be expanded with BACnet / EY-modulo 5 stations in this way.

Cross-communication between the EY-modulo 2 / EY3600 and the EY-modulo 5 stations can be centralised by means of the functions in SAUTER Vision Center.

Whether the connection between BACnet and novaNet is made via the SAUTER Vision Center control level, using the novaNet-BACnet application master, moduNet300 – or using both – must be decided in each specific case based on the number of addresses affected and the data streams etc.

7.3.2 LON, SAUTER EY-modulo 4

The integration of **SAUTER EY-modulo 4 stations** (that use the standardised LON databus), or the integration of third-party **LON stations** in the SAUTER management level with SAUTER Vision Center, is made via the LON OPC server and the SAUTER Vision Center OPC client.

7.3.3 OPC UA

SAUTER Vision Center can be used as an OPC UA client or as an additional UA/DA gateway, as long as it is an OPC DA server.

7.3.4 API interface

The API interface (Application Programming Interface) allows automated communication to take place with external programs. At the moment, connections to SAUTER EMS, Micromedia Alert are available and/or tools are included in SAUTER Vision Center such as alarm notification (alarms integrated in the Windows operating system bar) and Control Panel for SVC Windows services.

Integrated CASE Suite service

8 Integrated CASE Suite service

CASE Suite is the integrated service package from SAUTER. The **software bundle** contains all necessary programs and libraries for the different service steps within a project. From **planning** and **engineering** to **commissioning** and **maintenance**.

The 1st main benefit of the program package is that all **data** entered is used homogeneously during the entire project processing and thus only needs to be **entered once**. "Data entered once" such as one's own and third-party materials, services, data points, equipment and the functions thereof are available to all CASE programs for further processing. **This saves time, improves quality, reduces costs and helps to avoid errors.**

The 2nd main benefit are the extremely comprehensive **libraries with standard and sample solutions**. They allow a great deal of **increased rationalisation** when it comes to **service work**. In just a few steps, solutions can be put together from the libraries in accordance with the customer's requirements and can be individually adjusted at will. This compilation of systems out of "jigsaw" pieces is simple and optimises the engineering process. In addition to a high **quality of solution**, years of accumulated **system know-how by SAUTER specialists**, which is also found in these libraries, come particularly into their own. All the same, there is nothing to prevent customer-specific individual solutions at every stage of project processing.

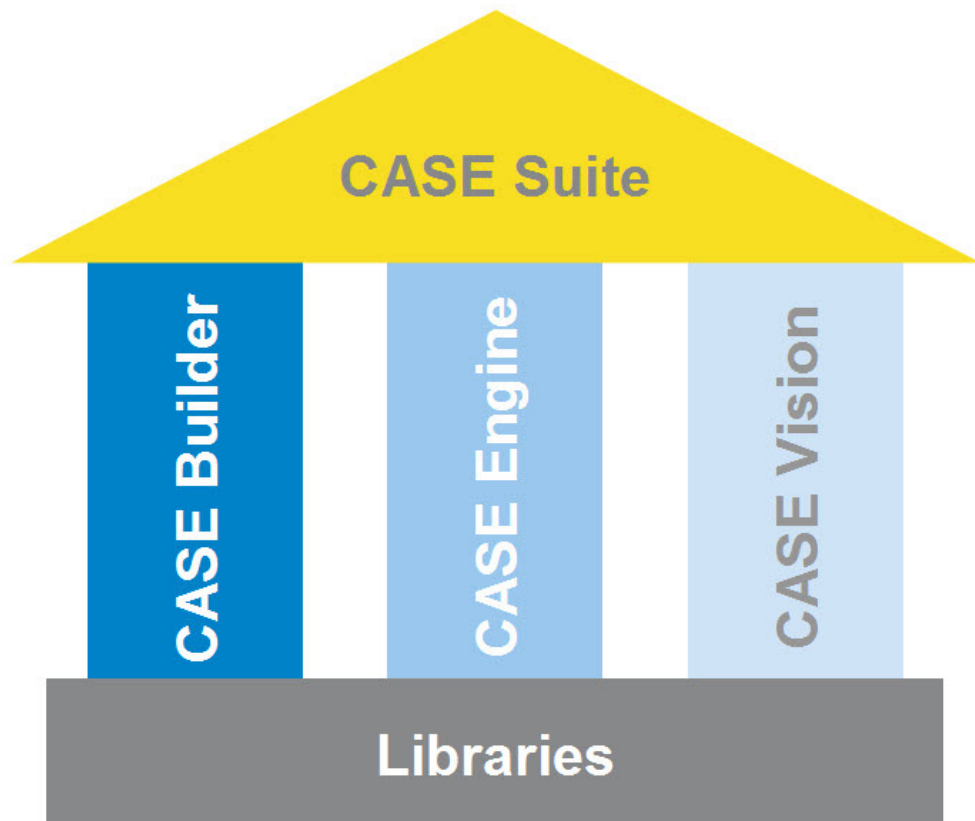

The **CASE Suite** platform includes the following programs:

8.1 CASE Builder

The CASE Builder program has been designed for rational use in **technical project handling**. Pursuing the principle of automatically re-using values recorded once, such as data points, equipment and their functions, in the entire course of the project, without having to re-enter them time and time again, a graphics program and Microsoft Office were used as a basis for developing a tool which meets this aim to a very large extent.

With its **comprehensive library**, CASE Builder very efficiently generates all the necessary documents for design and implementation and adapts them to the specific requirements of the project. When putting together an installation (graphically or in a tree structure) from the existing function groups, all the necessary information is compiled so that the following items can be created at the touch of a button:

- function descriptions
- device, cable, motor and valve lists
- data points lists, labels for the automation stations

The project data thus obtained is saved in a project database and can be used for subsequent project handling and documentation. The process plans and data

point information created by CASE Builder can be used by the SAUTER system visualisation applications.

8.2 CASE Engine

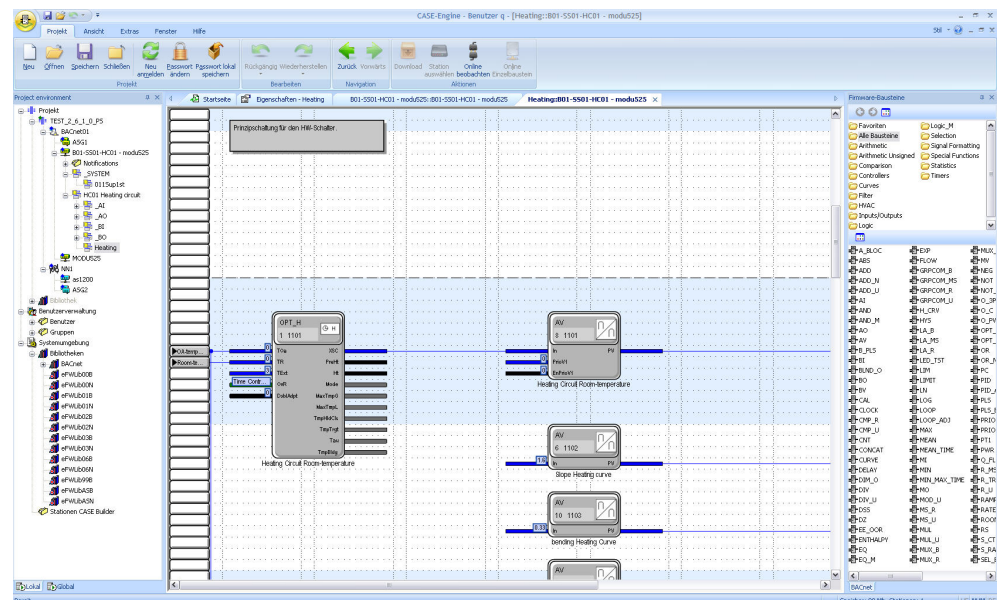

The CASE Engine editor and **integrated library** enable you to quickly create the graphics for the **system-specific automation station (AS) software** as part of the project. This allows the **function plans** to be created and the station parameters to be set. Control procedures are **graphically** represented and therefore easier to monitor.

The programming is based on the **IEC61131-3 (FBD) standard**, which makes using CASE Engine even easier. As well as this, CASE Engine allows you to work in a team. With access to a **shared project database**, the same information is available to all members of the team at the same time (simultaneous engineering).

Integrated CASE Suite service

8.3 CASE Vision

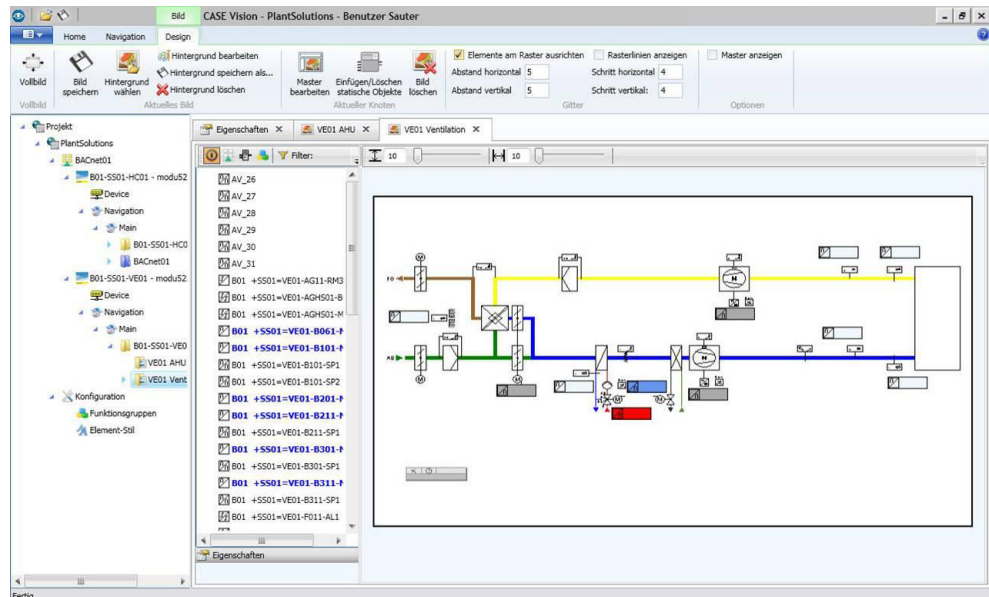

The CASE Vision program is designed for simple creation of **system navigation trees** and **dynamic** system diagrams for various visualisation applications from SAUTER.

The project data from CASE Engine is used as a data point reference. The images and navigation structures are prepared using CASE Vision and subsequently displayed in the visualisation applications or refined as necessary.

8.4 CASE Library Management

The **CASE Library Browser** program is designed for displaying the installed library packages and components, and also for deleting them when necessary.

The **CASE Library Manager** program allows administrators to create and manage library packages so that they can be distributed to users.

CASE Library Import can be used for integrating additional library packages in the CASE package. This means they are subsequently available to users when creating the project.

8.5 Components

CASE VAV

All the necessary settings for trouble-free operation of the ASV115 can be made in the menu of the CASE VAV software tool. As well as this, the most important input and output configuration parameters are factory-set for more efficient commissioning. Special online monitoring and troubleshooting functions are a useful supplement to the scope of functions.

CASE TPC (Touch Panel Configurator)

The CASE TPC software is designed for programming the EYT250 graphically. The software not only makes it easy to create the function interface, but also to configure and commission the EYT250 and to modify structures and parameters.

CASE Drives

CASE Drives is a program for commissioning the SAUTER ASM105SF132 and ASM115SF132 damper actuators and the AVM105SF132 and AVM115SF132 valve actuators. CASE Drives allows you to set and read the actuator parameters on site. Connection is made using a serial interface on the PC.

CASE Sensors

CASE Sensors allows you to configure and monitor SAUTER sensors. All parameters that can be modified using hardware operating equipment can be set using this application. As well as this, it also makes other parameters available for setting, depending on the device. CASE Sensors supports the following sensors: SGUF010/011 sash sensor and EGP and SDX differential pressure sensors.

8.6 Tools

The CASE tools offer various useful functions, including:

CASE Export BACnet

CASE Export allows you to make information from the automation stations such as parameters of I/O modules (house address, address text, dimensions etc.) available to other applications.

The CASE Export BACnet program creates EDE (Engineering Data Exchange) files (Format 2) for BACnet stations (SAUTER EY-modulo 5) and makes them available to other applications.

CASE Export novaNet

CASE Export novaNet provides three functions: exporting BMT parameters without groups (BMT 5.1), exporting BMT parameters with all tables (BMT 5.1 All Tables) and exporting the EDE file.

CASE Import

During modernisation projects or if an old automation station fails, stations from the EY2400 system are often replaced with state-of-the-art stations from the EY-modulo 5 system.

This is where CASE Import is used. The address designations of the EY2400 station do not have to be typed in again, but can be transferred from the EY2400-FuPlan project to a current EY-modulo 5 project with CASE Builder. As well as this, a terminal list with the old and new terminal numbers is created so that the existing equipment can be very easily connected to the EY-modulo 5 station.

Integrated CASE Suite service

BACnet Server Configurator

The IP address and other parameters of the novaNet-BACnet application master (EY-modulo 5 EY-AM 300) are configured using the SAUTER BACnet Server Configurator software module.

The configuration is transferred via the serial COM port (DB9 connector) or the Ethernet / IP port and saved in a flash memory where it is protected from power failure. Data transfer via IP takes place using the fixed TCP port 51966.

8.7 Communication

CASE HWC (hardware commissioning)

The hardware commissioning program is for efficiently checking the automation stations (novaNet AS) of the system and the connected field devices. After the hardware is commissioned, the program can be used for simple initial troubleshooting purposes.

CASE Sun

CASE Sun is the configuration tool for the automation stations and ecos stations in the SAUTER EY-modulo 5 range. CASE Sun enables you to perform the Ethernet network configuration, the 1:1 test during commissioning and update of the firmware on the stations if necessary. CASE Sun is designed both for SAUTER service engineers and for electricians on site.

novaNet292 Configurator

The novaNet292 Configurator is for configuring the novaNet292 Ethernet access device, setting the IP address of the port number etc.

novaVPort

novaVPort starts the communication driver for virtual COM ports. After selecting the configured driver to be started, you can use the novaNet292 VirtualPort Monitor to view the status and various information (such as version information) regarding novaNet292. If no application is using the port, users can stop the novaVPort driver.

novaMit29x

novaMit29x is an analysis tool for the novaNet communication protocol. It can record data transfer from the network and then analyse it.

9 Example applications

9.1 Railway station buildings in Austria

Smaller station buildings of various sizes spread throughout the state.

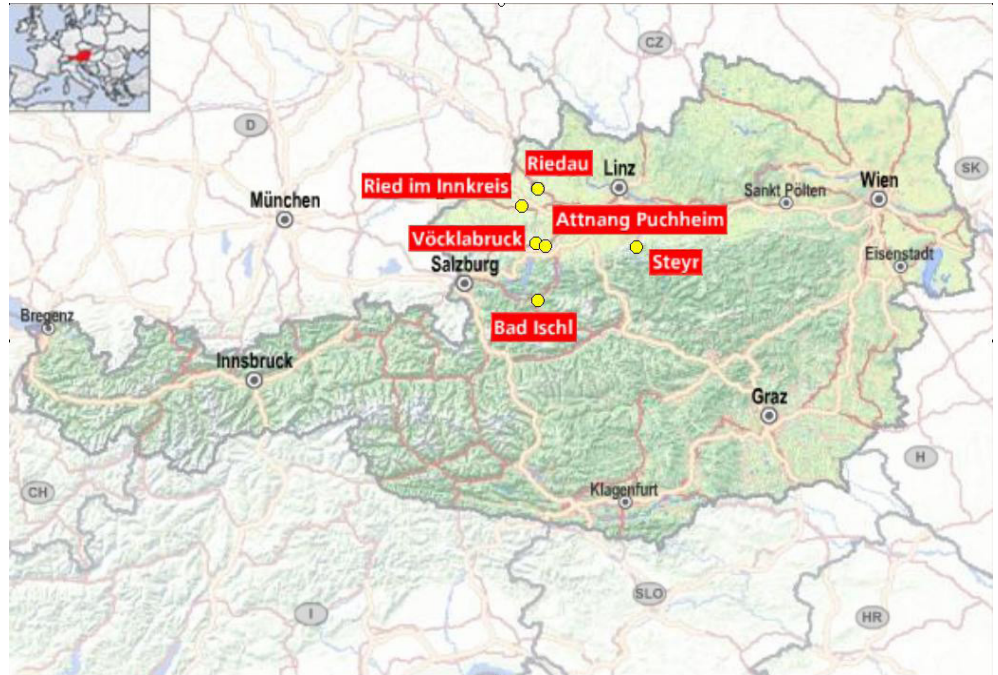

Requirements:

- Variable building size and accordingly different scope of control tasks (e.g. 1 x heat generation, 1 x solar plant (optional), 2-3 x radiator groups, 1 x hot-water provision)
- Central management and monitoring, but no management level
- Operation centrally and decentrally on the Internet via a web browser
- Local operation of the system at the AS and/or at the cabinet
- Central and decentralised alerting on the Internet via e-mail/SMS
- Customer LAN/WAN cannot be used for BMS.
- Minimisation of fixed and variable communication costs.

Solution with SAUTER EY-modulo 5:

- 1 modu525 AS per railway station, developed individually in a modular manner depending on the scope of the application.
- Local operation with the modu840 local operating device and/or modu625, 630, 650, 670 local operating/indicating units, depending on I/O modules fitted.
- Operation and indication, from/to the national centre, mobile operating stations and smartphones, via moduWeb in each station:

Example applications

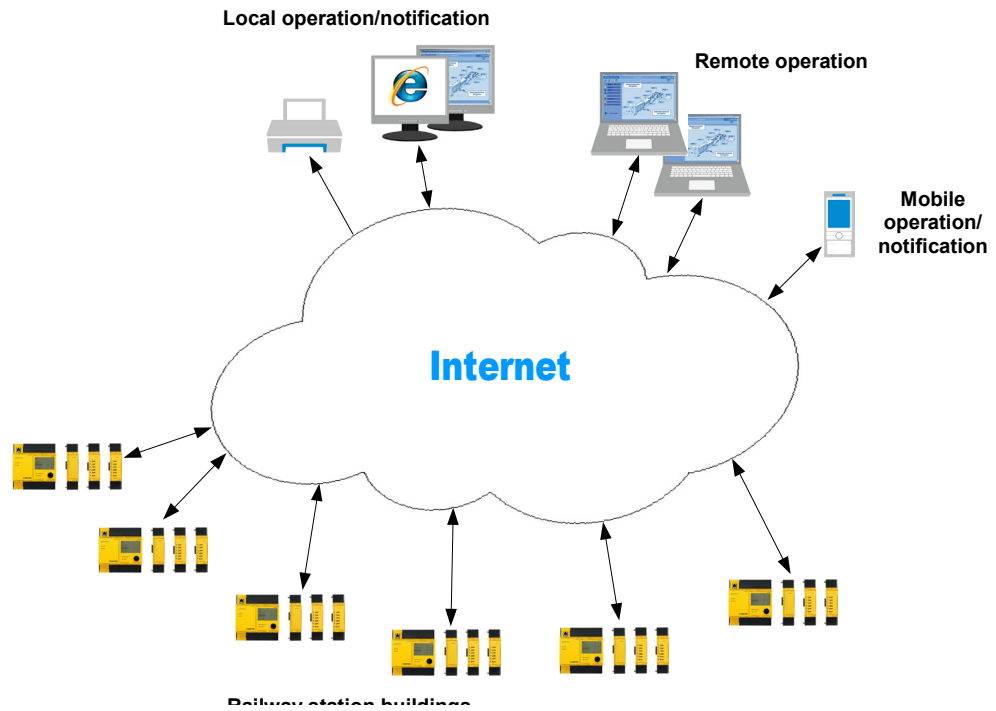

- cost-optimised connection to the Internet using a router with USB UMTS stick in every railway station.

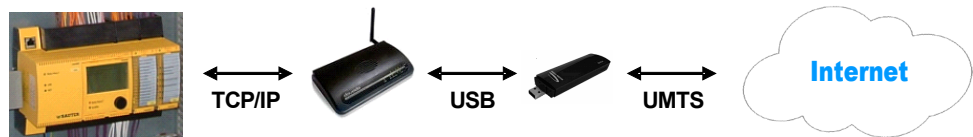

- Additional costs are minimised through the use of a DynDNS service instead of fixed IP addresses for access to the web servers in the stations.

Operation via moduWeb, installation list:

The screenshot shows the 'moduWeb - Bhf Ried T1' interface. On the left is a navigation menu with options like 'Abmelden [admin]', 'Status', 'Heizgruppe 1', 'Elektro', and 'Datenpunkte'. The main area displays a table of functional groups:

| Funktionsgruppen | Details | Istwert | Status |
|--|---------|---------|--------|
| WWB Zirkulationspumpe | | | |
| Zirk.-Pumpe - H04 Zirk.-Pumpe SB | [Icons] | 0 | ✓ |
| Zirk.-Pumpe - H04 Zirk.-Pumpe Stoer. | [Icons] | 0 | ✓ |
| WWB Speicher: Fühler mitte | | | |
| Temp. Speicher - H04 Temp. Speicher | [Icons] | 100 | ✓ |
| WWB Solar indirekt: WT, Pumpe, Kollektortemp. | | | |
| Solarpumpe pri. - H04 Solarpumpe pri. SB | [Icons] | 0 | ✓ |
| Solarpumpe pri. - H04 Solarpumpe pri. Stoer. | [Icons] | 0 | ✓ |
| WWB indirekt primär: VL-Fühler | | | |
| VL-Temp. pri. - H04 VL-Temp. pri. | [Icons] | 100 | ✓ |

Operation via moduWeb, installation graphic:

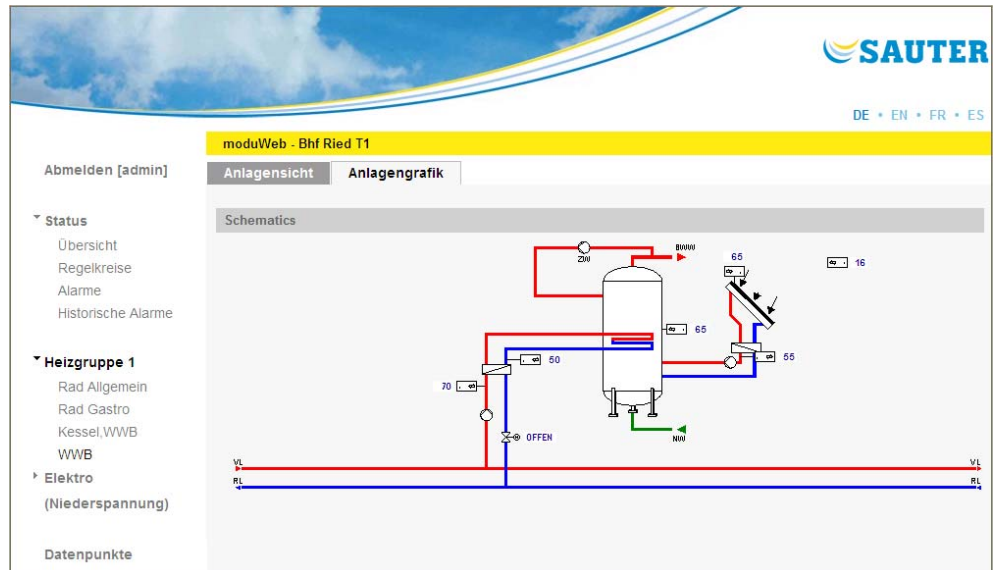

Operation via moduWeb, trend graphic:

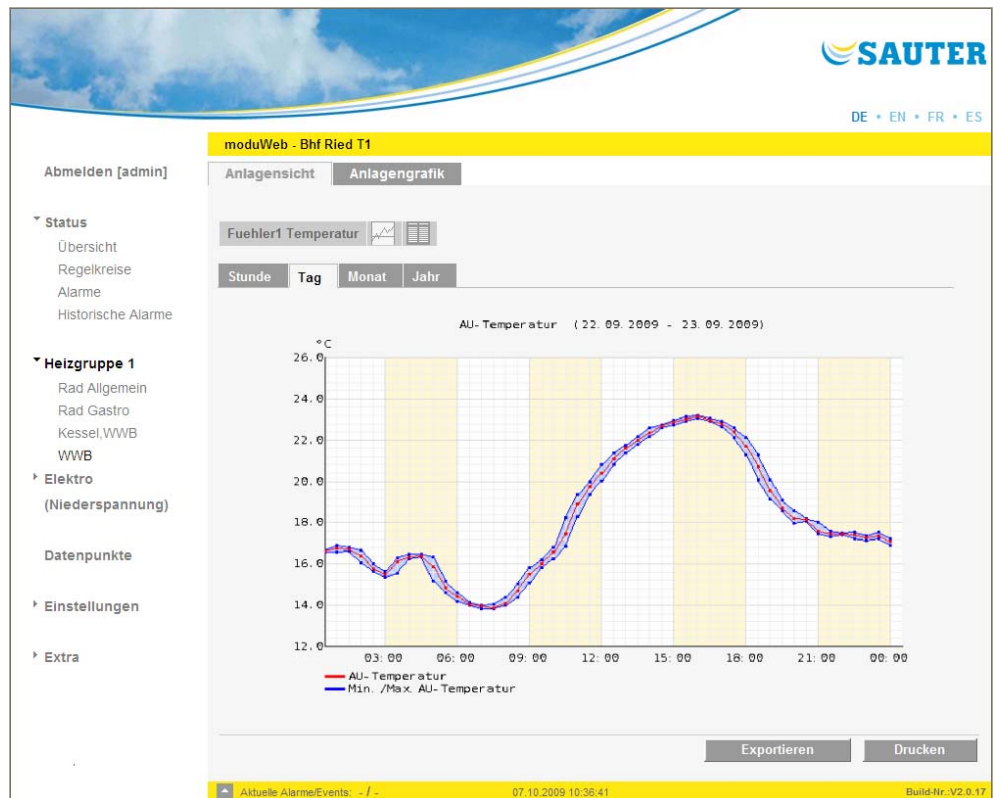

SAUTER EY-modulo 5 fulfils the requirements in this project without a control level in an ideal manner, thanks to its **modularity**, its comprehensive **local operating options** and thanks to the integrated remote control and alerting with **moduWeb**.

© Fr. Sauter AG
Im Surinam 55
CH-4016 Basel
Tel. +41 61 - 695 55 55
Fax +41 61 - 695 55 10
www.sauter-controls.com
info@sauter-controls.com